



**High  
Performance  
Carriers for  
Photovoltaic**

# Carriers

## for Wet Processing Systems

### SINGULUS TECHNOLOGIES – Innovations for New Technologies

SINGULUS TECHNOLOGIES develops and builds machines for economical and resource-efficient production processes. The application areas include vacuum thin-film and plasma coating, wet-chemical processes as well as thermal process technologies. For all machines, processes and applications SINGULUS TECHNOLOGIES utilizes its know-how in the areas of automation and process technology in order to develop additional, attractive work areas with innovative products next to the existing application areas.

#### Carrier for Chemical Wet Processing

High performance process carriers ensure excellent wafer and cell quality in high performance wet processing systems. SINGULUS TECHNOLOGIES has a long experience in providing complete automated dry-in/dry-out solutions for wet-chemical treatment of Si-wafers. The carriers are adjusted for the application in the wet processing system SILEX II from SINGULUS TECHNOLOGIES. The SILEX II with the integrated high

performance carriers from SINGULUS TECHNOLOGIES is used for wet-chemical treatment of standard and high-efficiency solar cells and achieves an output of up to 3,000 wph. The upscaling of the batch size will increase the capacity up to 6,000 wph. The SILEX II is running with very low scrap rates down to 0.01 % and a high process yield.

The carriers from SINGULUS TECHNOLOGIES are certified for all current and future batch process applications. These include alkaline texturing processes of mono-crystalline silicon, generating pyramidal-etched surfaces with optimal light trapping, passivation and contacting properties. The carriers are also optimized for the use in IPA-free texturing processes as well as common texturing and cleaning steps with advanced cleaning and conditioning processes. Their use offers substantial cost advantages compared to traditional systems.

The carrier from SINGULUS TECHNOLOGIES can be equipped with a transponder for tracking.

### Controlled pyramide structure provided by high performance process carriers in combination with SILEX II wet processing system from SINGULUS TECHNOLOGIES.

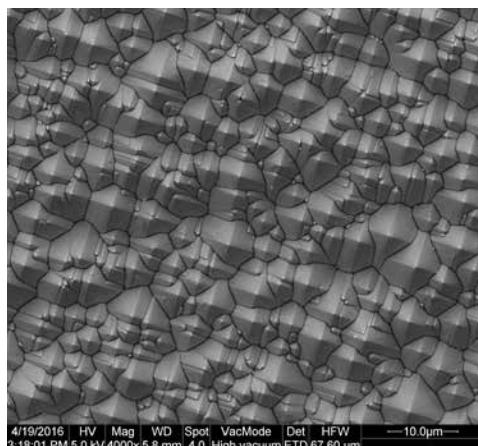

CellTex (L): Large (> 8 µm)

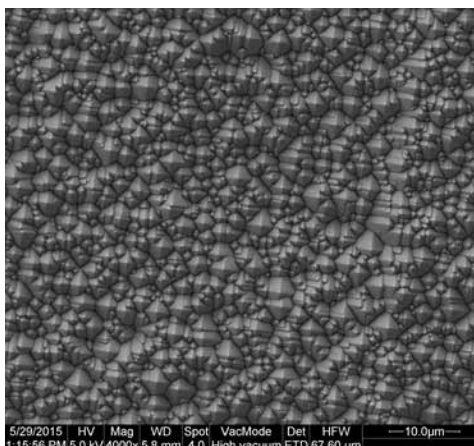

CellTex (M): Medium (4 – 6 µm)

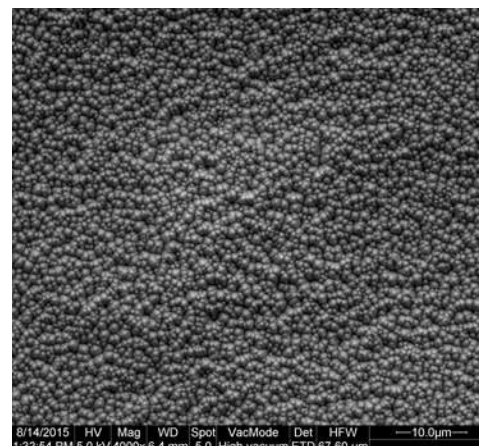

CellTex (S): Small (1 – 2 µm)

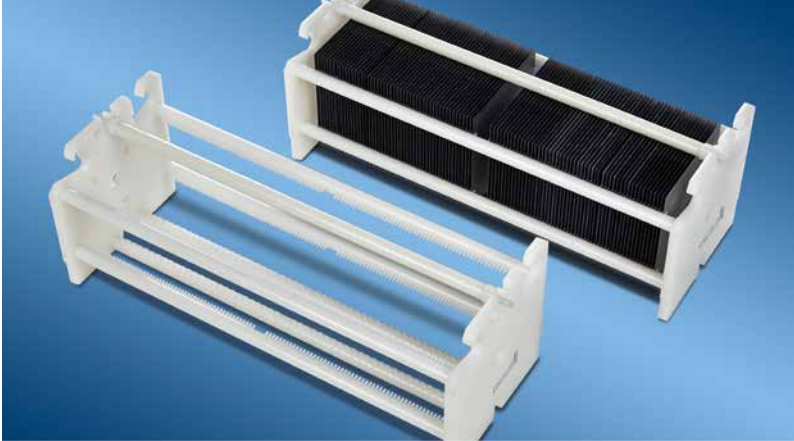

### Technical Advantages

- High quality product – Made in Germany
- Dimensional stability under extreme process conditions
- Save wafer processing down to 115 µm thickness
- Injection molded design with smooth surface finish
- Low chemical carry over design
- Integrated downholder for wafer
- Homogeneous etching with minimum shadowing and prevention of carrier marks
- Optimal rinse and spot-free drying performance
- Carrier up-flow prevention by proper weight & by SINGULUS wet process equipment
- Capacity max. 100 wafers, 6 point fixing – pitching 4.76 mm
- Wafer up-flow protection and additional wafer alignment by patent-pending retainer design
- RFID carrier identification with transponder

### Carrier Sizes

- **100 Wafers:** 5" – 125 x 125 mm
- **100 Wafers:** 6" – 156 x 156 mm
- **100 Wafers:** 156.75 mm +/- 0.15 mm
- **25/50 Wafers on request**

### Areas of Application Wet Processing

- Etching
- Cleaning
- Rinse
- Drying

### Carrier Materials

- **PVDF:** Chemical wet processing at high temperature up to 105 °C and/or strong oxidizing conditions (e.g. Ozone, NAOS)
- Other materials on request

### Reinforcement

- **SST:** Coated metal
- **RP:** Metal-free

### Labelling

- Unique SINGULUS serial ID

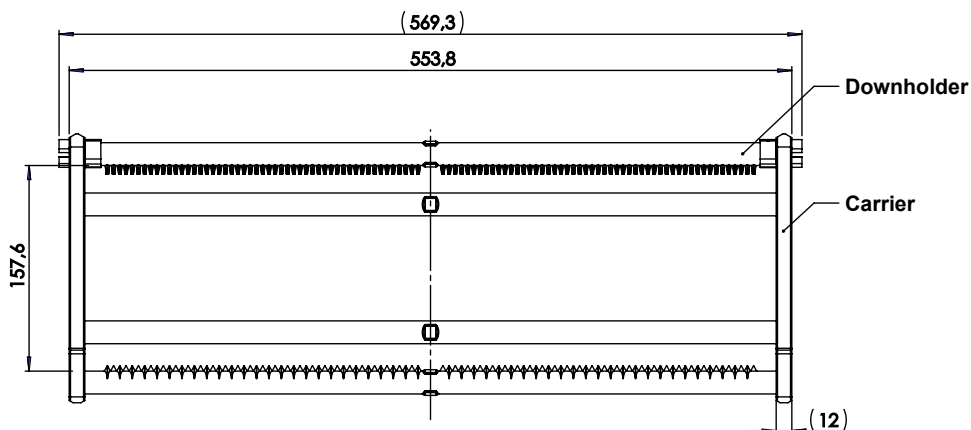
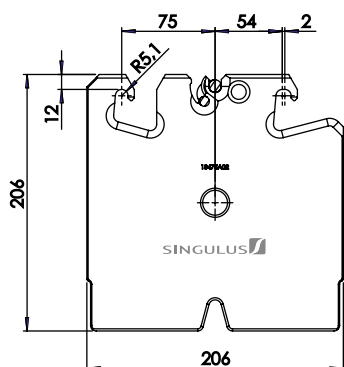



#### Headquarters

**SINGULUS TECHNOLOGIES AG**  
Hanauer Landstrasse 103  
D - 63796 Kahl, Germany  
Tel. +49 6188 440-0  
Fax +49 6188 440-130  
sales@singulus.de  
www.singulus.de

#### Production Site for Wet Processing Systems

**SINGULUS TECHNOLOGIES AG**  
Branch Office Fuerstenfeldbruck  
Fraunhoferstr. 9  
82256 Fuerstenfeldbruck, Germany  
Tel. +49 8141 3600-0  
Fax +49 8141 3600-100  
sales@singulus.de

#### Subsidiaries

**China**  
**SINGULUS TECHNOLOGIES  
(SHANGHAI) Co. Ltd.**  
Room B412-413, No. 1400 Jiangchang  
Road, Jingan District, Shanghai, China  
Zip Code: 200072  
Tel. +86 13916990710

Contact: Greens Pan  
Tel. +86 13822138376  
greens.pan@singulus.com.cn

Contact: Michael Han  
Tel. +86 13917382315  
michael.han@singulus.de

**France**  
**SINGULUS TECHNOLOGIES  
FRANCE S.A.R.L.**  
Tel. +33 3 893111-29  
singulus@club-internet.fr

**Latin America**  
**SINGULUS TECHNOLOGIES  
LATIN AMERICA LTDA.**  
Tel. +55 1121 6524-10  
sales@singulus.com.br

**Singapore**  
**SINGULUS TECHNOLOGIES  
ASIA PACIFIC PTE LTD.**  
Tel. +65 674 119-12  
sales@singulus.com.sg

**Taiwan**  
**SINGULUS TECHNOLOGIES  
TAIWAN LTD.**  
Tel. +886 2 2748-3366  
sales@singulus.com.tw

**United States and Canada**  
**SINGULUS TECHNOLOGIES INC.**  
Tel. +1 860 68380-00  
sales@singulus.com



THIN FILM  
DEPOSITION



SURFACE  
ENGINEERING

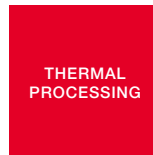

THERMAL  
PROCESSING

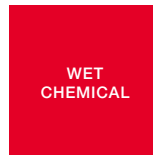

WET  
CHEMICAL

#### **SINGULUS TECHNOLOGIES – Innovations for New Technologies**

*SINGULUS TECHNOLOGIES builds innovative machines and systems for efficient and resource-friendly production processes. SINGULUS TECHNOLOGIES' strategy is to take advantage of its existing core competencies and to expand these further.*

*The core competencies include vacuum coating, surface processing, wet-chemical and thermal production processes. The company offers machines, which are used worldwide in the solar, semiconductor, medical technology, consumer goods and optical disc sectors. For all of the machines, processes and applications SINGULUS TECHNOLOGIES harnesses its automation and process technology expertise.*